

Supplementary Information

Title

Untangling the microbial ecosystem and kinetics in a nitrogen removing photosynthetic high density bioreactor †

Authors

Jacob R. Price^a, Saeed Keshani Langroodi^a, Yemin Lan^b, Jonas M. Becker^c, Wen K. Shieh^d, Gail L. Rosen^e, and Christopher M. Sales^{a*}

Footnotes

^a Civil, Architectural, and Environmental Engineering, Drexel University, 3141 Chestnut Street, Philadelphia, Pennsylvania 19104, United States

^b School of Biomedical Engineering, Science, and Health Systems, Drexel University, 3141 Chestnut Street, Philadelphia, Pennsylvania 19104, United States

^c Department of Biomimetics, Hochschule Bremen, Neustadtswall 30, D-28199 Bremen, Germany

^d Chemical and Biomolecular Engineering, The University of Pennsylvania, 220 S. 33rd Street, Philadelphia, Pennsylvania 19104, United States

^e Electrical and Computer Engineering, Drexel University, 3141 Chestnut Street, Philadelphia, Pennsylvania 19104, United States

* Corresponding Author. E-mail: chris.sales@drexel.edu. Phone: (215) 895-2155. Fax: (215) 895-1363.

† Electronic supplementary information (ESI) available.

Reactor Description and Operation

Figure S7 depicts the architecture of an HDBR system. The reactor (Reactor) was constructed with the addition of two ports (hose barbs) to a 1000 mL graduated cylinder, one at the 100 mL level and the other at the 1000 mL level. Reactor fluid is pumped through the bottom port and flows upwards through the reactor. Fluid leaving through the top port is directed to the recycle vessel (RV). The RV was constructed with the addition of two ports (hose barbs) to a 600 mL beaker, one at its base and the other at the 500 mL level. An aquarium aerator (A) provides aeration and mixing within the RV. Influent is pumped from the influent vessel (I) to the RV. Reactor effluent leaves the RV through its top port and is sent to a receiving waste container (W). The combination of upflow reactor design and fine control of recycle and mixing within the reactor allow for the establishment of a dense biomass zone (BZ) within the reactor vessel and eliminates the need for external settling or separation to be carried out¹⁻⁴. No biomass wastage was needed or carried out for the duration of the experiment.

Using the peristaltic pump controls, the reactor's influent flow rate was set to 1.5 mL min^{-1} (0.09 L hr^{-1}) and the recycle rate was set to 72.5 mL min^{-1} (4.35 L hr^{-1}), establishing a recycle ratio of 49.3. The total volume of the reactor, recycle vessel, and tubing is estimated to be 1600 mL; the hydraulic residence time for this reactor is 17.8 hr. A comprehensive discussion of the HDBR system and its adaption to a PBR configuration appears in Price et al, 2015⁴.

Sample Collection and Analytical Analysis

Influent and effluent samples were collected daily from the reactor influent and mixing vessels, vacuum filtered, and stored at -4° C . A Shimadzu Prominence HPLC/IC (Shimadzu Scientific Instruments, Columbia, MD) was used to analyze the samples for N species concentrations. NH_4^+ concentrations were determined using a Shodex IC YS-50 cation column (Shodex, NY, NY), with a flow rate of 1.0 mL min^{-1} , column oven temperature of 40° C , and a mobile phase composed of 4 mM Phosphoric acid. NO_2^- and NO_3^- concentrations were determined using a Shodex SI-52 4E anion column (Shodex, NY, NY), with a flow rate of 0.8 mL min^{-1} , column oven temperature of 45° C , and a mobile phase composed of 3.6 mM Na_2CO_3 .

Biomass Measurement

Biomass density was determined at the beginning and end of each reactor influent condition via standard methods⁵ as previously described⁴. The biomass values for dates between measurement days were linearly interpolated between the beginning and end values within the applicable condition. Some conditions lacked starting biomass measurements. In this case, the biomass value obtained at the end of a condition was extended backwards a maximum of 3 days. This enabled the addition of 4 points to the set, while minimizing noise induced from poorly realized biomass values.

Light and Scanning Electron Microscopy

Microbial samples were collected from the HDBR and observed using both light and scanning electron microscopy. Micrographs were analyzed using ImageJ image processing software ([www.http://imagej.nih.gov/ij/](http://imagej.nih.gov/ij/)) and features such as length, shape and diameter of objects found in light microscopy and SEM pictures were matched.

A Leitz Diaplan bright field microscope was initially used for exploratory work on undiluted samples. The high density of the flocs impaired the passage of light and impaired the quality of the image. Dilution of the sample and disruption of the flocs, via gentle pipetting, improved the image quality and resolution but interfered with observing the internal structure of the flocs. Observation under a Zeiss Axioskop 50 differential interference contrast (DIC) microscope resulted in much better resolution and enabled the tentative identification of single algal units.

SEM samples were collected and the biomass was allowed to settle overnight. Supernatant was decanted and the remaining biomass was slowly freeze dried for three days at a vacuum pressure of 0.21 mBar, a chamber temperature of -40° C, and sample temperature of 6° C. A small sub-sample was coated with Platin-Palladium solution for 15 seconds at 40mA using a Cressington 208HR sputter coater (Cressington Scientific Instruments, Watford, England), flushing the chamber two times with Argon before starting. Examination used a Zeiss Supra 50 VP field emission scanning electron microscope (Carl Zeiss Group, Oberkochen, Germany) at an acceleration voltage of 10 kV and working distances varying from 9 to 12 mm.

qPCR Standard Targets

Total Bacteria (16S rDNA) Target

```
>gi|16226005|gb|AF420301.1| Uncultured bacterium 16S ribosomal RNA
gene, partial sequence
ATGGCTGTTCGTCAGCTCGTGCCGTGAGGTGTTGGGTAAAGTCCCGCAACGAGCGCAACCCCTGCTTTCAG
TTGCTACCGGGTCATGCCGAGCACTCTGAAAGGACTGCCCAGGAGAACGGGGAGGAAGGTGGGGGTGACG
TCAAGTCAGCATGGCCTTTATGCCTGGGGCCACACACGTGCTACAATGGCCGGTACAAAGCGCTGCAAAC
CCGTGAGGGGGAGCCAATCGCAAAAAACCGGCCTCAGTTCAGATTGAGGTCTGCAACTCGACCTCATGAA
GGCGGAATCGCTAGTAATCGCGGATCAGCACGCCGCGGTGAATACGTTCCCGGGCCTTGTACACACCGCC
CGTCACACCACGAAAGCCTGTTGTACCTGAAGTCGCCACGCCAACC GCAAGGAGGCAGTGCCACGGTA
TGGCCGGTGATTGGGTG
```

Chlamydomonas reinhardtii (rbcL) Target

```
CAGCAACGAAAAGGAAACGGTCACGCCAACGCATGAATGGTTGTGAGTTTACGTTTTTCGTCGTCTTTAGT
AAAGTCAAGACCACCACGTAAACATTCATAAACTGCACGACCG
```

Parachlorella kessleri (rbcL) Target

```
ACAACCTAAAAGAGCACGACCGTATTTGTTAAGTTTATCACGTTCAACTTGAATACCATGTGGAGGCCCT
TGGAAATGTTTTTACATATGCTGGTGGAAATACGAAGATCTTCTAAACGTAATGCACGAAGTGCTTTGAAAC
CAA
```

References

1. C. M. Sales and W. K. Shieh, *Water Res*, 2006, **40**, 1442-1448.
2. K. Nootong and W. K. Shieh, *Bioresour Technol*, 2008, **99**, 6292-6298.
3. G. Ramanathan, C. M. Sales and W. K. Shieh, *Water Sci Technol*, 2014, **70**, 729-735.
4. J. R. Price, W. K. Shieh and C. M. Sales, *J. Vis. Exp.*, 2015, DOI: 10.3791/53443, e53443.
5. APHA, AWWA and WPCF, *Standard Methods for the Examination of Water and Wastewater*, American Public Health Association, Washington, DC, 16 edn., 1985.
6. M. J. Ferris, G. Muyzer and D. M. Ward, *Appl Environ Microbiol*, 1996, **62**, 340-346.
7. D. J. Lane, B. Pace, G. J. Olsen, D. A. Stahl, M. L. Sogin and N. R. Pace, *Proc Natl Acad Sci U S A*, 1985, **82**, 6955-6959.
8. G. A. Kowalchuk, J. R. Stephen and D. W. Boer, *Appl. Environ. Microbiol.*, 1997.
9. J. H. Rotthauwe, K. P. Witzel and W. Liesack, *Applied and Environmental Microbiology*, 1997, **63**, 4704-4712.
10. V. Degrange and R. Bardin, *Appl Environ Microbiol*, 1995, **61**, 2093-2098.
11. B. Vanparys, P. Bodelier and P. De Vos, *Curr Microbiol*, 2006, **53**, 255-257.
12. H. M. Dionisi, A. C. Layton, G. Harms, I. R. Gregory, K. G. Robinson and G. S. Sayler, *Appl Environ Microbiol*, 2002, **68**, 245-253.
13. G. Braker, A. Fesefeldt and K. P. Witzel, *Appl Environ Microbiol*, 1998, **64**, 3769-3775.
14. I. N. Throback, K. Enwall, A. Jarvis and S. Hallin, *FEMS Microbiol Ecol*, 2004, **49**, 401-417.
15. G. Braker and J. M. Tiedje, *Appl Environ Microbiol*, 2003, **69**, 3476-3483.
16. K. Kloos, A. Mergel, C. Rösch and H. Bothe, *Functional Plant Biology*, 2001, **28**, 991.

Table S1: Specific Loading Rates				
Index	Influent Condition	Specific Loading (mg -N hr ⁻¹ g BM ⁻¹)		Biological Sample Id
		NH ₄ ⁺	NO ₃ ⁻	
1	2	1.66	0.00	
2	2	1.49	0.00	
3	2	1.57	0.00	
4	2	1.22	0.00	C2
5*	3	1.17	0.43	C3
6	4	0.54	0.33	
7	4	0.48	0.31	
8	4	0.53	0.32	C4
9	5	0.46	1.36	
10	5	0.51	1.44	
11	5	0.45	1.15	
12	5	0.53	1.47	
13	5	0.46	1.29	
14	5	0.43	1.33	
15	5	0.53	1.31	
16	5	0.40	1.02	
17	5	0.38	0.91	
18	5	0.48	1.35	C5
19	8	0.67	0.81	
20	8	0.74	0.87	
21	8	1.37	1.64	
22	8	0.99	1.03	
23	8	0.88	0.97	
24	8	0.72	1.17	C8
25	9	0.50	0.00	
26	9	0.54	0.00	
27	9	0.49	0.00	
28	9	0.32	0.06	
29	9	0.27	0.07	
30	9	0.27	0.06	
31	9	0.34	0.07	
32	9	0.41	0.09	
33	9	0.52	0.10	
34	9	0.86	0.11	
35	9	0.78	0.12	
36	9	0.91	0.10	
37	9	0.82	0.13	
38	9	0.85	0.12	
39	9	0.85	0.13	C9

* Not used for regression analysis

Table S2: Biological samples and extracted DNA concentrations					
Influent Condition	Total Biomass [g]	Biomass Volume [L]	Biomass Density [g/L]	Biological Replicate	DNA Conc [ng/ μ L]
2	1.85	0.79	2.34	2-1	10.1
				2-2	11
				2-3	8.66
3	1.76	0.58*	3.03	3-1	12.5
				3-2	9.75
				3-3	17.2
4	1.69	0.70	2.41	4-1	14
				4-2	14
				4-3	10.2
5	1.24	0.80	1.55	5-1	7.62
				5-2	6.96
				5-3	6.84
8	1.44	0.76	1.91	8-1	17.3
				8-2	19.7
				8-3	17.7
9	0.90	1.00**	0.90	9-1	1.79
				9-2	2.18
				9-3	2.12

* Estimated biomass value

** Biomass was suspended for biological and biomass density sampling.

Table S3: MG-RAST Project Data and Quality Control Statistics		
Sequencing Technology	Illumina HiSeq 2500	
Project Name	p_reactor	
Metagenome Name	CSJP002B	CSJP002C
MG-RAST Metagenome ID	4632722.3	4632723.3
Upload: bp Count	6,609,374,438	5,276,493,424
Upload: Sequences Count	23,098,919	18,378,192
Upload: Mean Sequence Length (bp)	286 ± 67	287 ± 68
Upload: Mean GC (%)	54 ± 14	56 ± 14
Artificial Duplicate Reads: Sequence Count	1,099,951	574,241
Post QC: bp Count (bp)	4,336,518,992	3,575,544,668
Post QC: Sequences Count	19,488,329	15,917,436
Post QC: Mean Sequence Length (bp)	222 ± 93	224 ± 93
Post QC: Mean GC percent (%)	54 ± 14	55 ± 13
Processed: Predicted Protein Features	10,089,146	8,090,086
Processed: Predicted rRNA Features	169,962	135,175
Alignment: Identified Protein Features	4,281,784	3,365,875
Alignment: Identified rRNA Features	3,733	3,461
Annotation: Identified Functional Categories	3,376,080	2,633,453

Table S4: qPCR Primers

Target Organism	Target Loci	Primer/Target	Sequence	Reference
Tot Bac	16S	1055f	ATGGCTGTCGTCAGCT	6
		1392r	ACGGGCGGTGTGTAC	6, 7
<i>Chlamydomonas reinhardtii</i>	rbcL	rbcL_cr_F	CAGCAACGAAAAGGAAACGG	this study
		rbcL_cr_R	CGGTCGTGCAGTTTATGAATG	this study
<i>Parachlorella kessleri</i>	rbcL	rbcL_pk_F	ACAACCTAAAAGAGCACGACC	this study
		rbcL_pk_R	TTGGTTTCAAAGCACTTCGTG	this study
AOB	16S	CTO189fA/B	GGAGRAAAGCAGGGGATCG	8
		CTO189fC	GGAGGAAAGTAGGGGATCG	8
		CTO654R	CTAGCYTTGTAGTTTCAAACGC	8
AOB	amoA	amoA-1F	GGGGTTTCTACTGGTGGT	9
		amoA-2R	CCCCTCKGSAAAGCCTTCTTC	9
<i>Nitrobacter sp</i>	16S	FGPS872	TTTTTTGAGATTTGCTAG	10
		FGPS1269'	CTAAAACTCAAAGGAATTGA	10
<i>Nitrobacter sp</i>	nxB	NxB 1F	ACGTGGAGACCAAGCCGGG	11
		NxB 1R	CCGTGCTGTTGAYCTCGTTGA	11
<i>Nitrospira sp</i>	16S	NSR1113f	CCTGCTTTCAGTTGCTACCG	12
		NSR1264r	GTTTGCAGCGCTTTGTACCG	12
denitrifiers	nirK	nirK 1F	GGMATGGTKCCSTGGCA	13
		nirK 5R	GCCTCGATCAGRTRRTGGTT	13
denitrifiers	nirS	nirS cd3AF	G TSAACG TSAAGGARACSGG	14
		nirS R3cd	GASTTCGGRTGSGTCTTGA	14
denitrifiers	nor	cnorB-2F	GACAAGNNNTACTGGTGGT	15
		cnorB-6R	GAANCCCCANACNCCNGC	15
denitrifiers	nosZ	nosZ-F	CGYTGTTCMTCGACAGCCAG	16
		nosZ 1162R	CGSACCTTSTTGCCSTYGCG	14

Table S5: Results of simple linear regression

Dependent Variable	Predictor Variable	n	P-value
Sp Removal Total N	Sp Loading Total N	38	0.2969
	Sp Loading NH ₄ ⁺	38	0.7806
	Sp Loading NO ₃ ⁻	38	0.1354
Sp Removal NH ₄ ⁺	Sp Loading Total N	38	0.8408
	Sp Loading NH ₄ ⁺	38	0.008387
	Sp Loading NO ₃ ⁻	38	0.06454
Sp Removal NO ₃ ⁻	Sp Loading Total N	38	0.6224
	Sp Loading NH ₄ ⁺	38	0.006409
	Sp Loading NO ₃ ⁻	38	0.009696

Table S6: MG-RAST Relative Taxonomic Abundance		
Sequencing Technology	Illumina HiSeq	
Project Name	p_reactor	
Metagenome Name	CSJP002B	CSJP002C
MG-RAST Metagenome ID	4632722.3	4632723.3
Condition	3	5
NH ₄ ⁺ Loading (mg -N / hr /g BM)	1.17	0.48
NO ₃ ⁻ Loading (mg -N / hr /g BM)	0.43	1.35
α-diversity	350.4	395.7
Domain		
Archaea	0.3%	0.4%
Bacteria	96.7%	96.7%
Eukaryota	2.9%	2.8%
Ammonia-oxidizing bacteria		
<i>Nitrosomonas</i>	0.34%	0.62%
<i>Nitrosococcus</i>	0.26%	0.34%
<i>Nitrospira</i>	0.68%	1.21%
Total	1.28%	2.16%
Nitrite-oxidizing bacteria		
<i>Nitrobacter</i>	2.48%	2.32%
<i>Nitrospina</i>	-	-
<i>Nitrococcus</i>	0.09%	0.15%
<i>Nitrospira</i>	0.07%	0.00%
Total	2.64%	2.48%
Algae		
<i>Chlamydomonas</i>	0.30%	0.05%
<i>Parachlorella</i>	0.09%	0.13%
Cyanobacteria		
<i>Leptolyngbya</i>	0.00%	0.00%

Table S7: Reads Mapped to Reference Genome

	Condition	Accession Number	Genus	Species	Total Reads [absolute count]	Percent of Reads [%]
Algae	C3	213517384	<i>Chlamydomonas</i>	<i>reinhardtii</i>	18896	11.2%
		229915563	<i>Parachlorella</i>	<i>kessleri</i>	11016	6.6%
		254798615	<i>Parachlorella</i>	<i>kessleri</i>	11007	6.5%
	C5	32880373	<i>Chlamydomonas</i>	<i>reinhardtii</i>	9595	5.7%
		41179002	<i>Chlamydomonas</i>	<i>reinhardtii</i>	9561	5.7%
		229915563	<i>Parachlorella</i>	<i>kessleri</i>	13419	27.0%
Cyanobacteria	C3	254798615	<i>Parachlorella</i>	<i>kessleri</i>	13268	26.6%
		984535223	<i>Leptolyngbya</i>	Strain O-77	582	31.9%
	C5	984535223	<i>Leptolyngbya</i>	Strain O-77	495	32.2%

Table S8: Relative Gene Abundance (Relative to Condition 5)

Organism / Target	Primer Pair	Statistic	Influent Condition					
			2	3	4	5	8	9
AOB 16S	CTO	Avg	0.82	0.55	1.81	1.00	0.71	0.48
		SE	0.02	0.01	0.02	0.01	0.02	0.01
		p-value	3.35E-08	2.74E-17	1.11E-16		1.48E-10	8.28E-17
AOB amoA	amoA	Avg	0.76	0.46	2.05	1.04	0.59	0.20
		SE	0.06	0.04	0.16	0.11	0.05	0.02
		p-value	3.77E-02	1.19E-04	8.26E-05		1.72E-03	9.93E-07
<i>Nitrobacter sp.</i> 16S	FGPS	Avg	2.39	3.23	2.23	1.01	2.23	0.21
		SE	0.13	0.25	0.09	0.04	0.08	0.01
		p-value	1.81E-08	2.20E-07	1.57E-09		4.84E-10	4.91E-12
<i>Nitrobacter sp.</i> nxrB	NxrB	Avg	1.07	0.97	1.99	1.00	1.66	0.61
		SE	0.01	0.04	0.03	0.01	0.04	0.01
		p-value	2.57E-03	4.97E-01	8.01E-16		2.08E-10	9.16E-14
<i>Nitrospira sp.</i> 16S	NSR	Avg	0.82	0.74	2.03	1.01	1.17	1.75
		SE	0.05	0.04	0.22	0.05	0.07	0.09
		p-value	1.23E-02	2.86E-04	4.09E-04		5.65E-02	1.18E-06
denitrifying bacteria nirK	nirK	Avg	1.77	1.39	2.25	1.28	1.70	2.04
		SE	0.35	0.28	0.48	0.32	0.33	0.40
		p-value	3.10E-01	8.00E-01	1.11E-01		3.70E-01	1.56E-01
denitrifying bacteria nirS	nirS	Avg	0.59	1.24	1.92	1.00	1.41	0.53
		SE	0.01	0.04	0.02	0.01	0.03	0.01
		p-value	6.38E-13	5.21E-05	3.16E-16		3.25E-10	2.54E-14
denitrifying bacteria nor	nor	Avg	1.54	1.21	1.05	1.00	0.46	1.23
		SE	0.13	0.10	0.01	0.01	0.00	0.03
		p-value	8.18E-04	4.74E-02	1.68E-02		5.68E-18	9.75E-07
denitrifying bacteria nosZ	nos	Avg	1.16	1.41	1.57	1.00	1.32	1.21
		SE	0.03	0.02	0.02	0.01	0.02	0.03
		p-value	8.63E-05	7.93E-11	1.01E-12		2.41E-10	5.49E-06

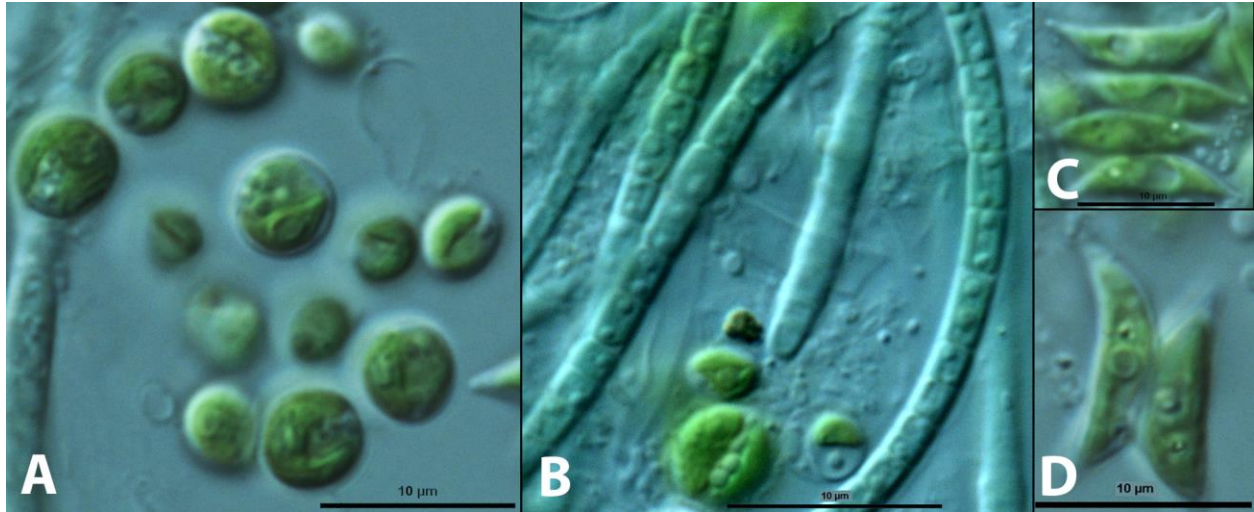

FigureS1: A Composite of micrographs taken with DIC microscopy. A) little round green things (LRGT), B) filamentous segmented cyanobacteria, tentatively identified as *Leptolyngbya* sp., C) *Scenedesmus dimorphous*, and D) a close relative of *Scenedesmus dimorphous*.

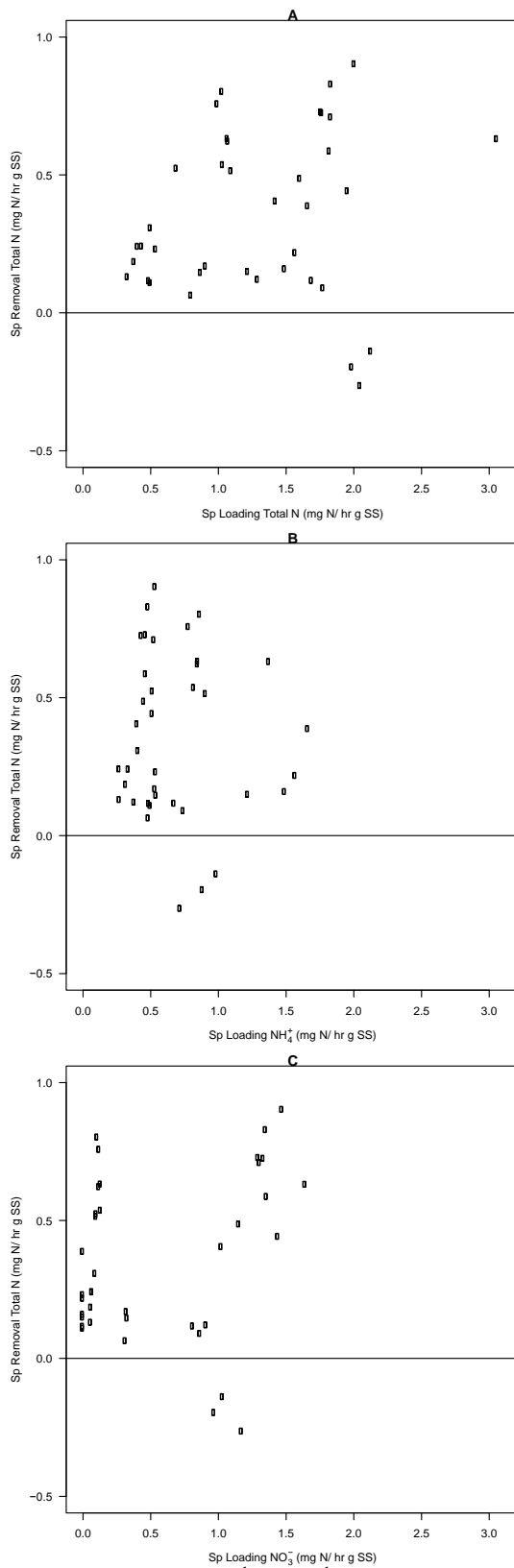
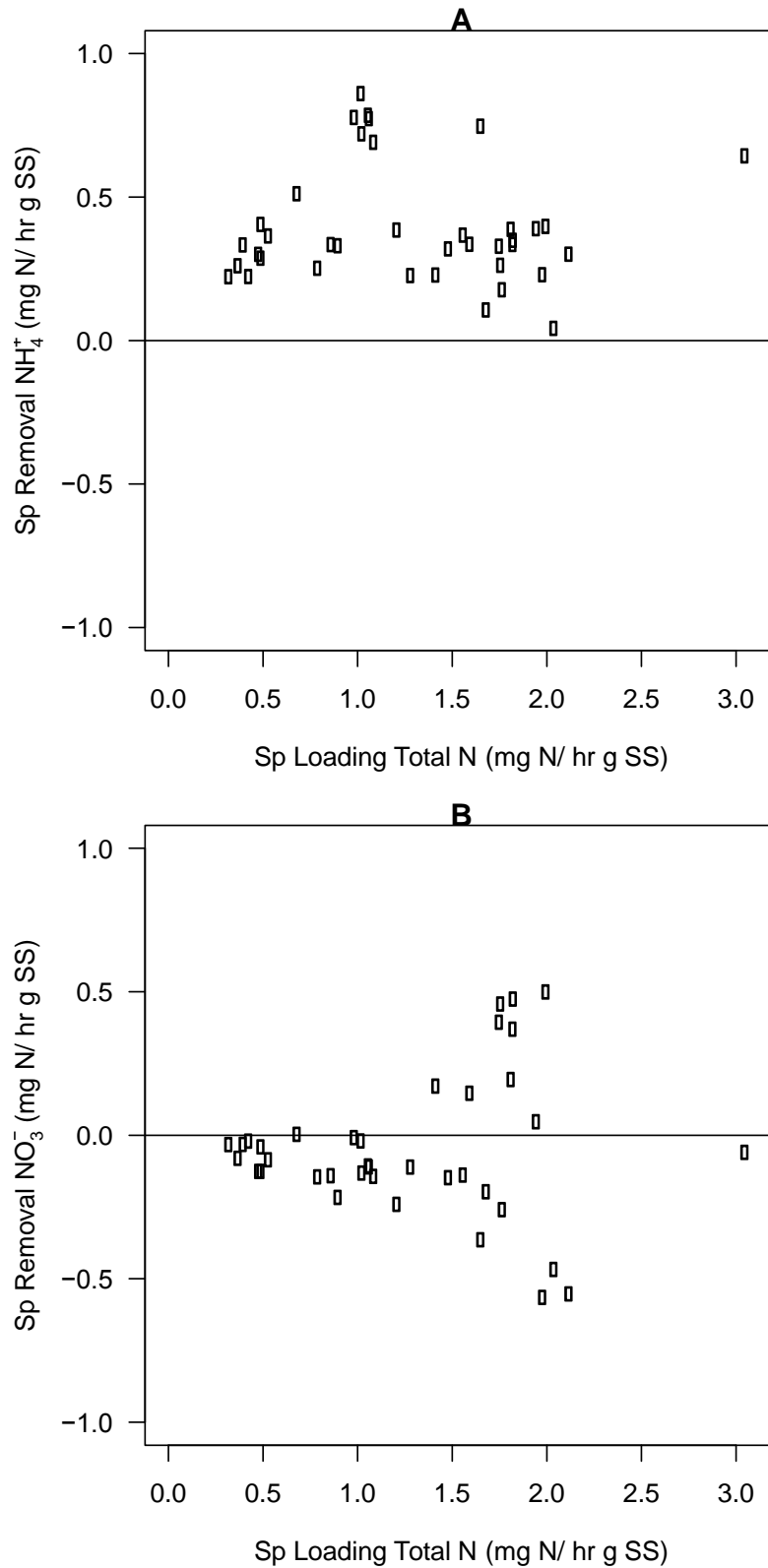

Figure S2: Specific removal rate of total N ($\text{mg N hr}^{-1} \text{g SS}^{-1}$) versus specific loading rates of (A) total N, (B) NH_4^+ , and (C) NO_3^- ($\text{mg N hr}^{-1} \text{g SS}^{-1}$).



FigureS3: Specific removal rate of (A) NH_4^+ and (B) NO_3^- ($\text{mg N hr}^{-1} \text{g SS}^{-1}$) versus specific loading of total N ($\text{mg N hr}^{-1} \text{g SS}^{-1}$).

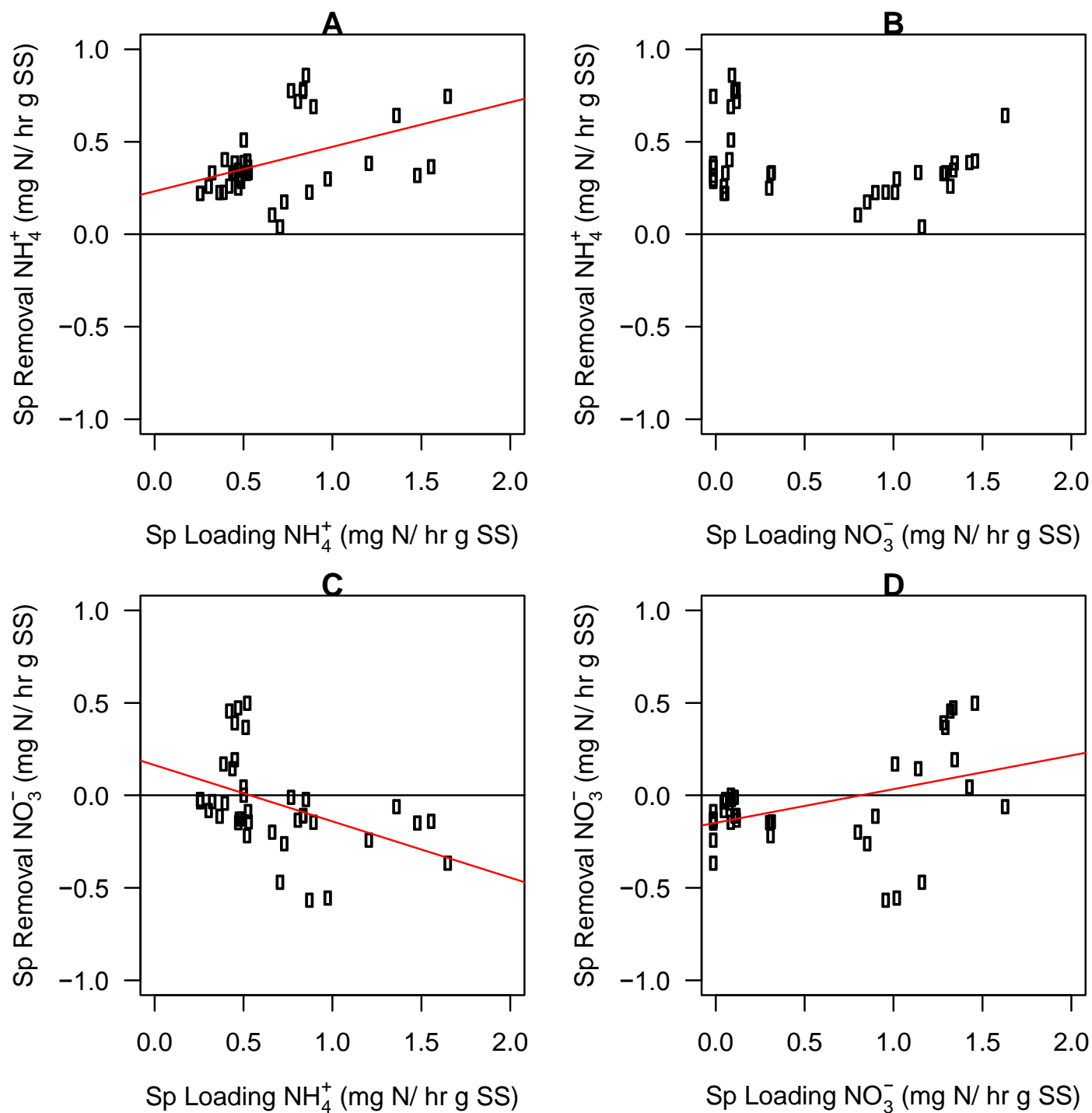

Figure S4: Specific NH₄⁺ and NO₃⁻ removal rates (mg N hr⁻¹ g SS⁻¹) versus specific loading rates (mg N hr⁻¹ g SS⁻¹).

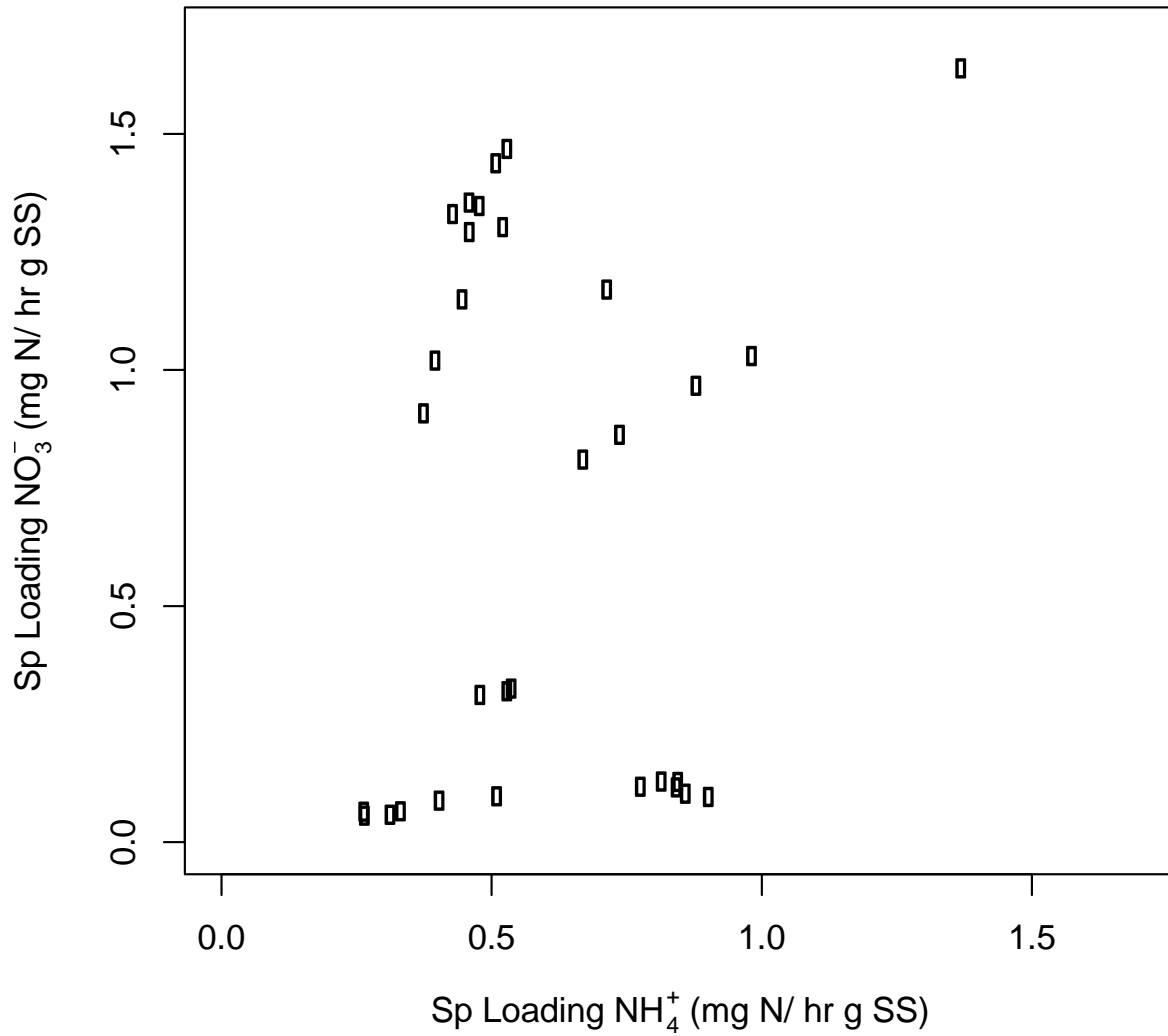

Figure S5: The domain of specific loading rates used for the generation of **Figure 4**. Points possessing a specific NO₃⁻ loading rate of zero were removed.

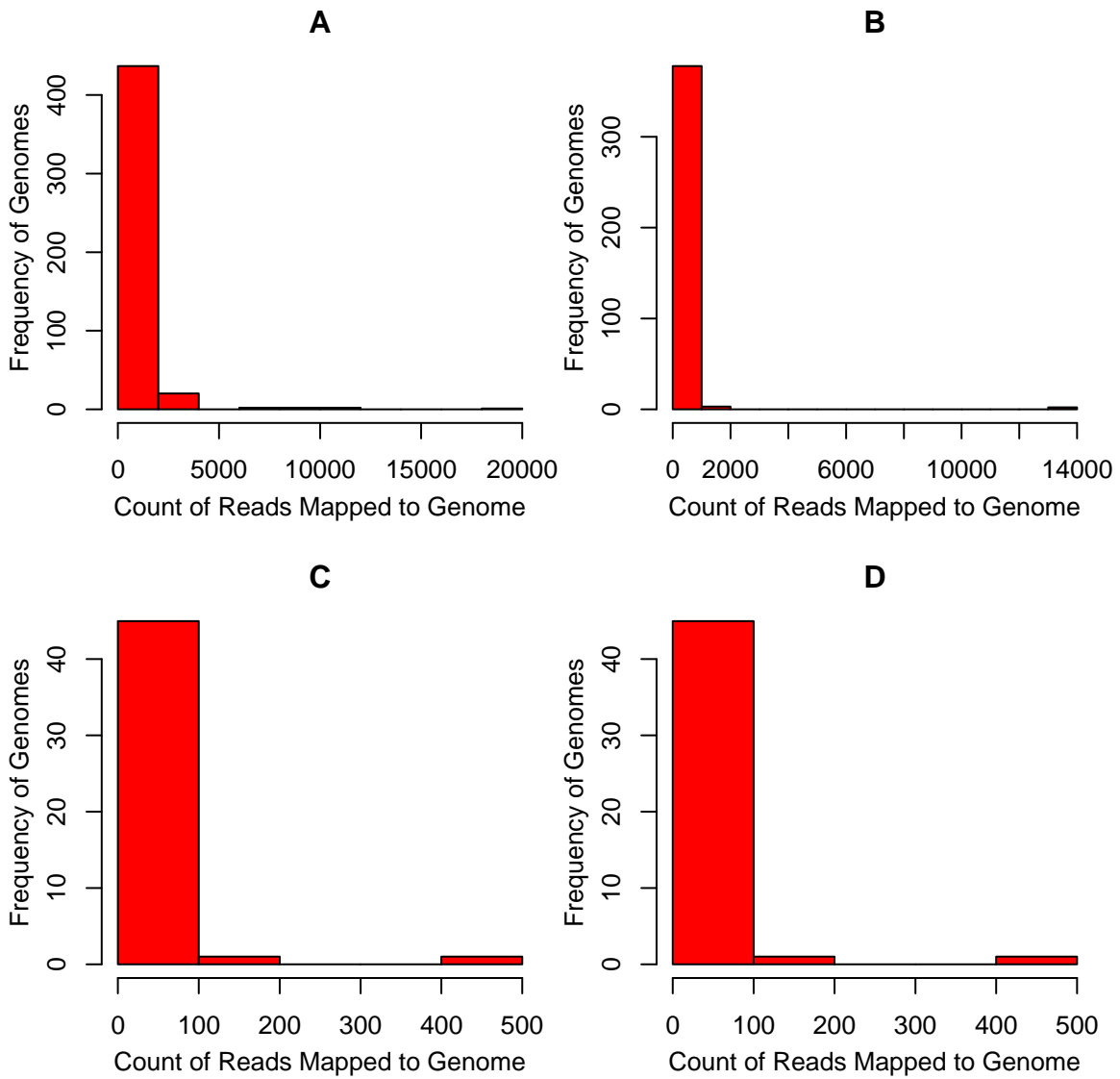

Figure S6: Histograms of reads mapped to algal and cyanobacterial genomes: A) Condition 3 reads mapped to algae, B) Condition 5 mapped to algae, C) Condition 3 mapped to cyanobacteria, D) Condition 5 mapped to cyanobacteria.

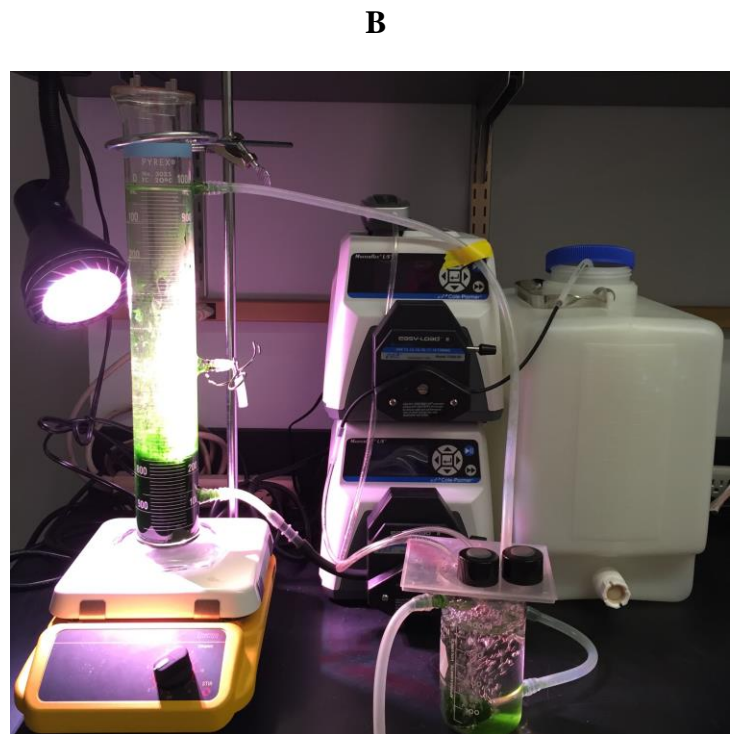
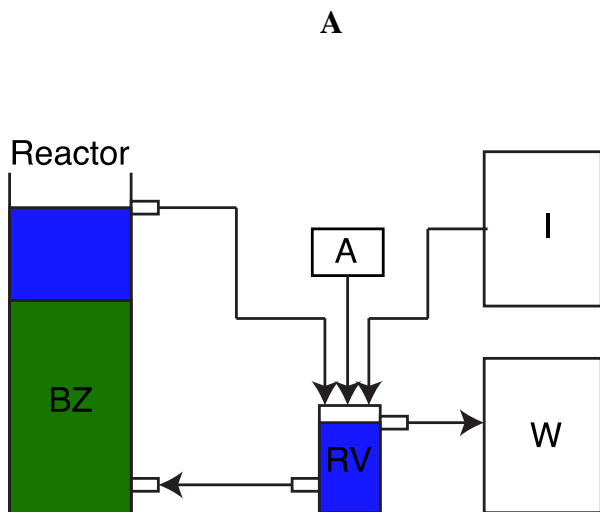

Figure S7: (Panel A) Schematic of the HDBR system (not to scale). The major components of the HDBR are the reactor (Reactor), the recycle vessel (RV), an aerator (A), a vessel to hold reactor influent (I), and a waste container to receive reactor effluent (W). The HDBR architecture enables a dense and distinct biomass zone (BZ) to form within the reactor. (Panel B) Photograph of the HDBR system in use. The biomass forms a highly dense zone at the bottom of the reactor while the remaining reactor fluid and effluent contains limited suspended solids.